



### Key Features



- 50 Ohm Impedance
- 2.2 ~ 2.7 GHz
- 1.1 dB Noise Figure
- 26.0 DBm Output IP<sub>3</sub>
- 15.0 dB Gain
- +/-0.3 dB Gain Flatness
- 13.0 dBm P<sub>1dB</sub>
- 1.25:1 VSWR
- Single Power Supply
- >34 Years MTBF
- RoHS Compliant

### Product Description



WEA104 is integrated with WanTcom proprietary low noise amplifier technology, high frequency micro electronic assembly techniques, and high reliability design to realize optimum low noise figure, wideband, and high linearity performances together. With single +5.0V DC operation, the amplifier has optimal input and output matching in the specified frequency range at 50-Ohm impedance system. The amplifier has standard SMA connectorized WP-10E Gold plated housing.

The amplifier is designed to meet the rugged standard of MIL-STD-202g.

### Applications

- Mobile Infrastructures
- WiMax
- 3G
- PCS
- Security System
- Measurement
- Fixed Wireless



### Specifications

Summary of the electrical specifications WEA104 at room temperature

Index	Testing Item	Symbol	Test Constraints	Min	Nom	Max	Unit
1	Gain	S <sub>21</sub>	2.2 – 2.7 GHz	14.5	15	16	dB
2	Gain Variation	ΔG	2.2 – 2.7 GHz		+/- 0.3	+/-0.75	dB
3	Input VSWR	SWR <sub>1</sub>	2.2 – 2.7 GHz		1.25:1	1.45:1	Ratio
4	Output VSWR	SWR <sub>2</sub>	2.2 – 2.7 GHz		1.25:1	1.45:1	Ratio
5	Reverse Isolation	S <sub>12</sub>	2.2 – 2.7 GHz	20	22		dB
6	Noise figure	NF	2.2 – 2.7 GHz		1.1	1.3	dB
7	Output Power 1dB compression Point	P <sub>1dB</sub>	2.2 – 2.7 GHz	10	13		dBm
8	Output-Third-Order Interception point	IP <sub>3</sub>	Two-Tone, P <sub>out</sub> +0 dBm each, 1 MHz separation	24	26		dBm
9	Current Consumption	I <sub>dd</sub>	V <sub>dd</sub> = +5 V	20	23	26	mA
10	Power Supply Voltage	V <sub>dd</sub>		+4.7	+5	+5.3	V
11	Thermal Resistance	R <sub>th,c</sub>	Junction to case			220	°C/W
12	Operating Temperature	T <sub>o</sub>		-40		+85	°C
13	Maximum Average RF Input Power	P <sub>IN, MAX</sub>	DC – 6 GHz			10	dBm

### Absolute Maximum Ratings

Parameters	Units	Ratings
DC Power Supply Voltage	V	7.0
Drain Current	mA	30
Total Power Dissipation	mW	250
RF Input Power	dBm	10
Channel Temperature	°C	150
Storage Temperature	°C	-55 ~ 125
Operating Temperature	°C	-40 ~ 85
Thermal Resistance	°C/W	220

Operation of this device above any one of these parameters may cause permanent damage.

### Functional Block Diagram

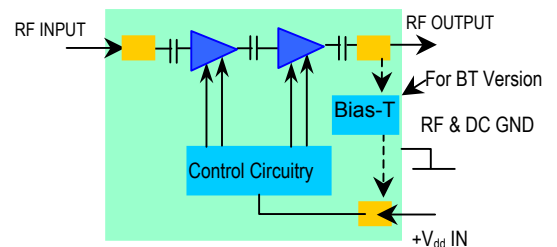

### Ordering Information

Model Number	Feature
WEA104	Without Bias-T at Output
WEA104BT	With Bias-T at Output

Specifications and information are subject to change without notice.



**Typical Data**

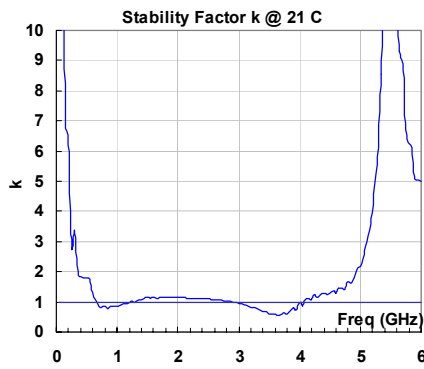
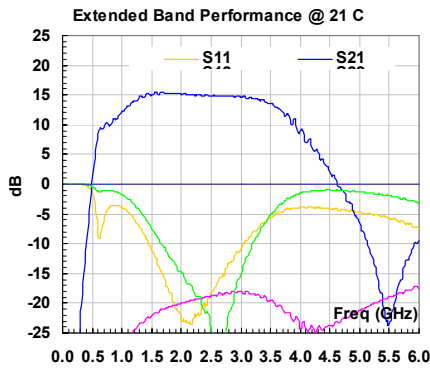
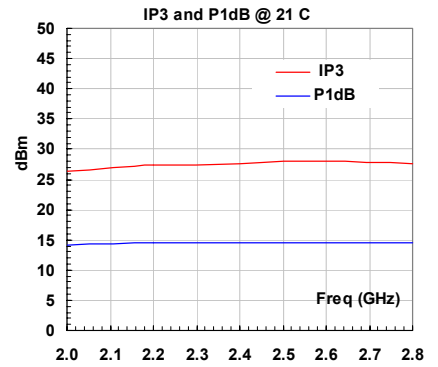
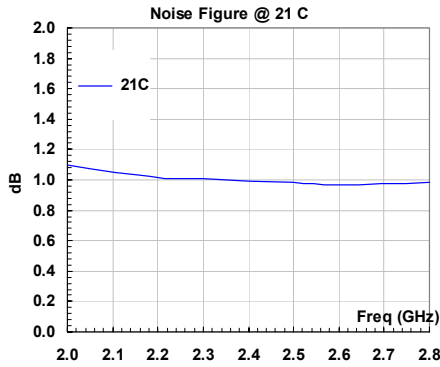
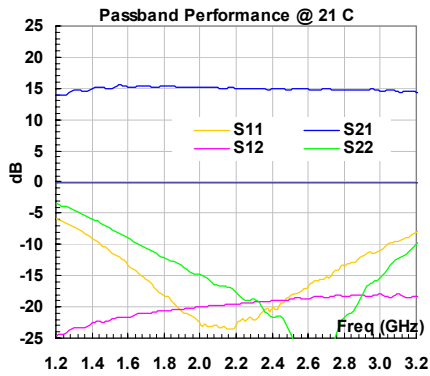

**Outline, WP-10E Housing**

UNITS: INCH [mm]  
 BODY: Brass  
 Finish: Gold Plating  
 RF Connector: SMA F Gold  
 V<sub>dd</sub> PWR: Feed through

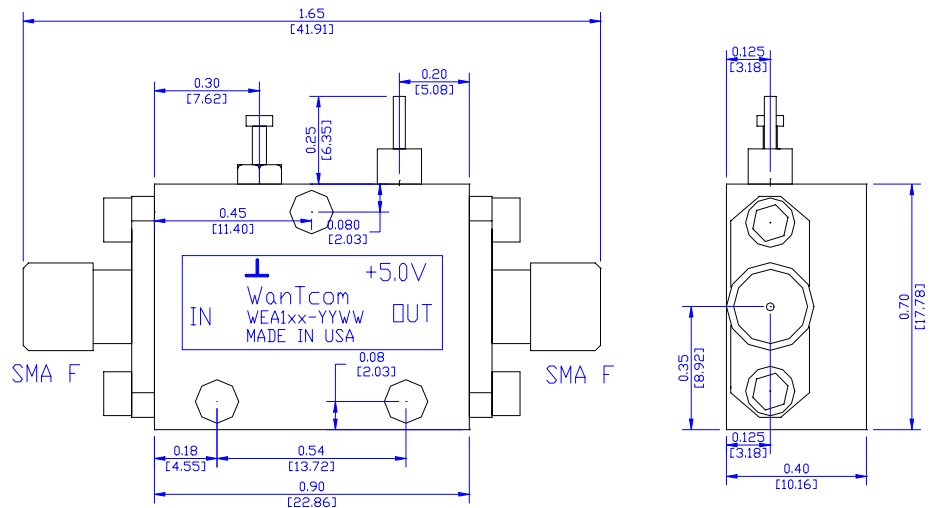

Specifications and information are subject to change without notice.



## Application Notes:

### SMA Torque Wrench Selection

Always use a torque wrench with 5 ~ 6 inch-lb coupling torque setting for mating the SMA cable connectors to the amplifier connectors. Never use torque more than 8 inch-lb wrench for tightening the mating cable connectors to the amplifier connectors. Otherwise, the permanent damage may occur to the SMA connectors of the amplifier. 8710-1582 (5 inch-lb) wrench from Agilent Technology is one of the ideal example.

### DC Power Line Connection

Strip the insulation layer at the end of DC power supply wire. The stripped distance should be in the range of 0.100" to 0.200". The 24 ~ 26 American Wire Gauge wire is suitable. Wound the stripped terminal wire about 1 turn on the DC feed thru center pin. Solder the wounded wire and the center pin together. Clean the soldering area by Q-tip with alcohol to remove the flux and residue.

Repeat the process to solder the DC return wire on the ground turret. It is always helpful to use different color wires for DC wire and ground wire, such as red and black one.

### Mounting the Amplifier

Use three pieces of #4-40 with longer than 9/16" screws for mounting the amplifier on a metal-based chase. Flat and spring washers are needed to prevent the screw loosening during the shock and vibration. Always use the appropriate torque setting of the power screwdriver to mount them.

\*\*\*\*\*