



WMA1R5A

1.5T LOW NOISE LOW INPUT IMPEDANCE PRE-AMPLIFIER

REV D
May 2019

Key Features



- For 50 Ohm Source Impedance
- 1.5T Frequency of 63.8 MHz
- 1.5 Ohm Input Impedance
- 0.40 dB Noise Figure
- 30.0 dBm Max P_{IN}
- 20.0 dBm Output IP_3
- 28.0 dB Gain
- 10.0 dBm P_{1dB}
- 1.22:1 Output VSWR
- Unconditional Stable, $k > 1$
- Single Power Supply
- None Magnetic

Product Description

With its low input impedance, WMA1R5A is designed for 50 Ohm source impedance multi-channel coil applications. The pre-amp maintains excellent noise figure performance over source impedance variation that either comes from the different loads to the coils or not ideal design implementation of the coils. Moreover, the pre-amp allows higher source impedance design to increase the blocking impedance while maintaining superior SNR due to large equal noise circles.

The amplifier has 0.60" x 0.40" x 0.10" surface mount package.



Applications

- Magnetic Resonance Imaging
- RF Measurement
- Medical
- Current Sensor



Specifications

Other frequencies and impedance available!

Summary of the key electrical specifications at room temperature, which are tested in WanTcom test fixture, 80051

Index	Testing Item	Symbol	Test Constraints	Min	Nom	Max	Unit
1	Gain	S_{21}	63.8 MHz	27.5	28.0	28.5	dB
2	Gain Variation	ΔG	63.8 +/- 1 MHz			+/- 0.1	dB
3	Input Impedance	RE [Zin]	63.8 MHz		1.5	2.0	Ohm
		IM [Zin]	63.8 MHz, with test fixture 80051	-2.0	0	2.0	Ohm
4	Output VSWR, 50 Ohm Impedance	SWR_2	63.8 MHz			1.22:1	Ratio
5	Reverse Isolation	S_{12}	63.8 MHz	55	60		dB
6	Noise Figure	NF	63.8 MHz, $Z_s = 50$ Ohm		0.40	0.55	dB
7	Output Power 1dB Compression Point	P_{1dB}	63.8 MHz	7	10		dBm
8	Output-Third-Order Interception point	IP_3	Two-Tone, $P_{out} = 0$ dBm each, 1 MHz separation	16	20		dBm
9	Current Consumption	I_{dd}	$V_{dd} = +10.0$ V		16		mA
10	Power Supply Operating Voltage	V_{dd}		+7	+10	+11	V
11	Thermal Resistance	$R_{th,c}$	Junction to case			220	$^{\circ}C/W$
12	Operating Temperature	T_o		+10		+60	$^{\circ}C$
13	Maximum RF Input Power	$P_{IN,MAX}$	DC - 6.0 GHz, 10% Duty Cycle, $Z_s = 50$ Ohm			30	dBm
14	Saturate Recover Time	t_{sr}	10% to 90% from 20 dBm Pin, $Z_s = 50$ Ohm		8	10	μS
15	ESD Protection, None Contact	V_{ESDN}	Output Port			16	kV
16	ESD Protection, Direct Contact	V_{ESD}	Output Port			6	kV

Absolute Maximum Ratings

Parameters	Units	Ratings
DC Power Supply Voltage	V	12.0
Drain Current	mA	30
Total Power Dissipation	mW	350
RF Input Power, 10% Duty Cycle, $Z_s = 50$ Ohm	dBm	30
Junction Temperature	$^{\circ}C$	150
Storage Temperature	$^{\circ}C$	-65 ~ 150
Operating Temperature	$^{\circ}C$	0 ~ +70
Thermal Resistance ¹	$^{\circ}C/W$	215

Operation of this device beyond any one of these parameters may cause permanent damage.

Functional Block Diagram

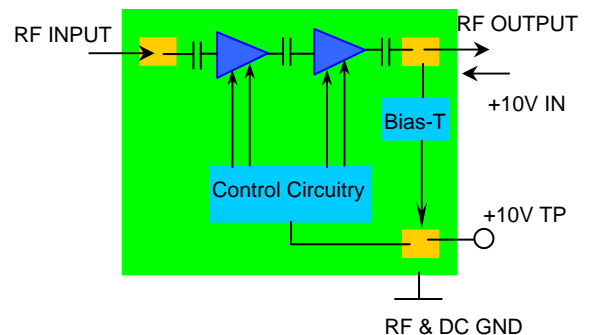

¹ The last stage transistor dominates the heat dissipation. The drain bias voltage is +6V and the drain current is 15.0 mA. The total power dissipation of the last stage transistor is thus 90 mW. The junction temperature arise $0.09 \times 220 = 20$ ($^{\circ}C$).

Specifications and information are subject to change without notice.



Ordering Information

Model Number	WMA1R5A
---------------------	---------

Waffle shell is used for the packing. Contact factory for tape and reel packing option for higher volume order.

Typical Data

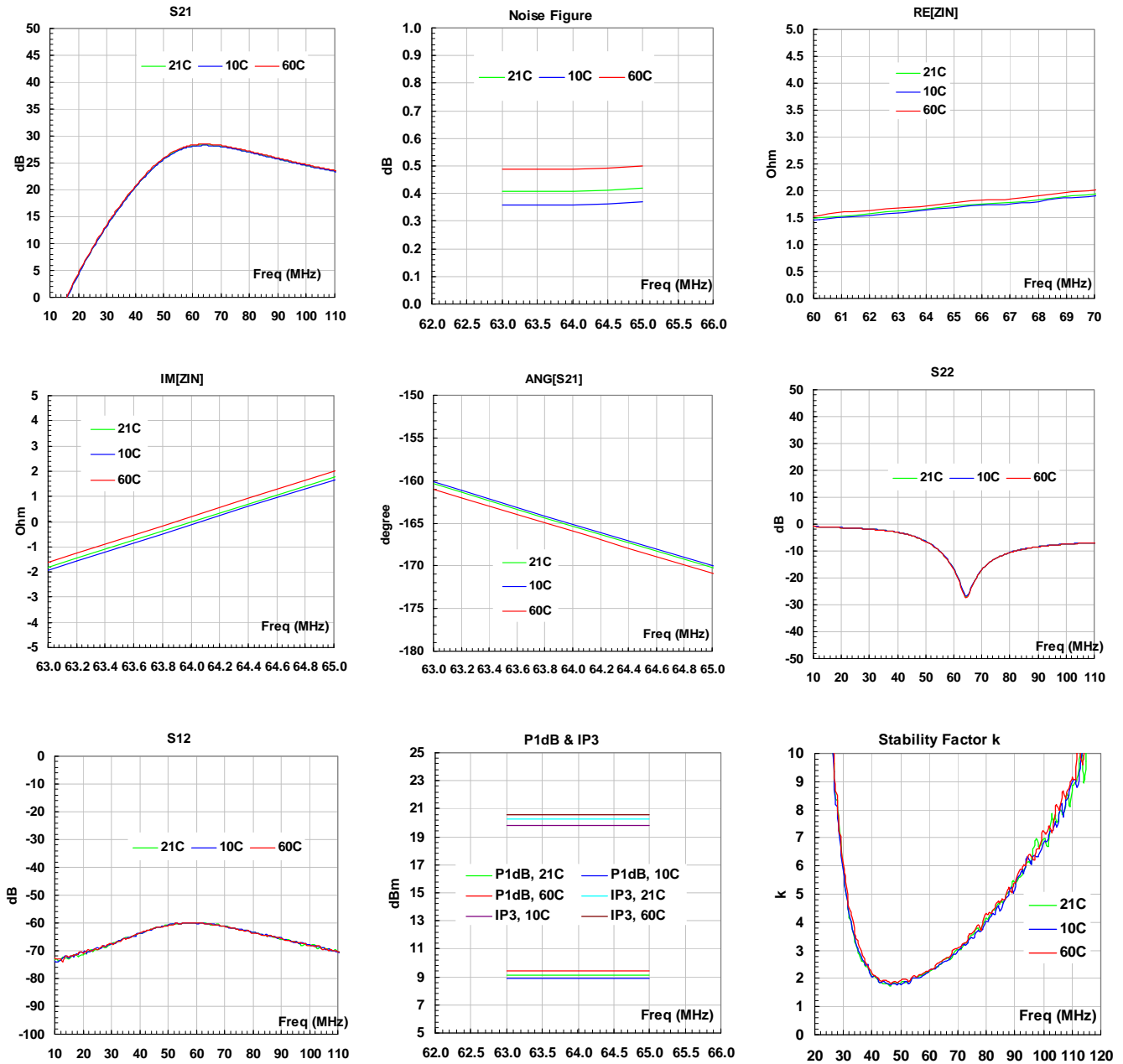

Specifications and information are subject to change without notice.



WMA1R5A

1.5T LOW NOISE LOW INPUT IMPEDANCE PRE-AMPLIFIER

REV D
May 2019

Outline,

PIN	1	2	3	4	CNTR
FCTN	IN	NC/10V	OUT/10V	GND	GND

UNITS: INCH
[mm]
FINISH: WHITE TIN

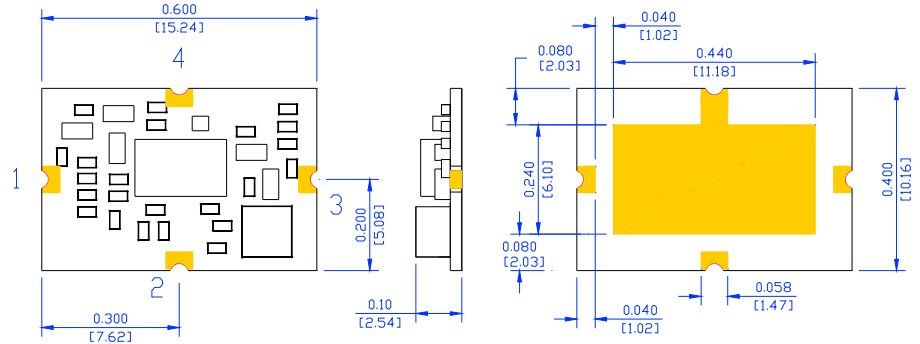

Foot Print/Mounting Layout

PIN	1	2	3	4	CNTR
FCTN	IN	NC/10V	OUT/10V	GND	GND

UNITS: INCH
[mm]
FINISH: WHITE TIN

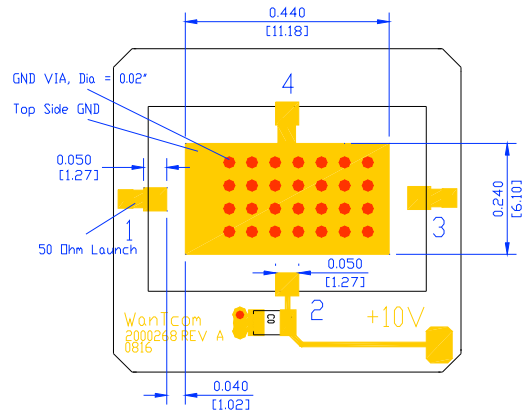

Specifications and information are subject to change without notice.



Application Notes:

A. Motherboard Layout

The recommended motherboard layout is shown in the diagram of [Foot Print/Mounting Layout](#). Sufficient quantities of ground vias on center ground pad are essential for the RF grounding. The width of the 50-Ohm microstrip lines at the input and output RF ports may be different for different property of the substrate. The ground plane on the backside of the substrate is needed to connect the center ground pad through the vias. The ground plane is also essential for the 50-Ohm microstrip line launches at the input and output ports.

In order to have stable pre-amp in the coil system, the minimum system isolation of 55 dB between the input and output soldering pads for the preamp with all the components including the coils on the feed board is required. Poor system isolation can introduce external feedback either in pass band or off band and cause the pre-amp parasitic oscillation. Measure the S_{12} or S_{21} between the input and output pads without the installation of the pre-amp is essential to insure the stable preamp operation.

The +10V DC voltage can be applied at Pin 2 or at the output Pin 3. There is a built-in bias-T at the output port to separate the RF output signal and the input +10V DC power supply. Pin 2 and Pin 3 are DC connected internally.

No DC block capacitor is required at input port.

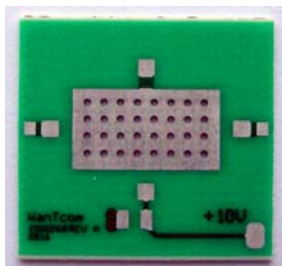

Fig. 1 Example of the test board

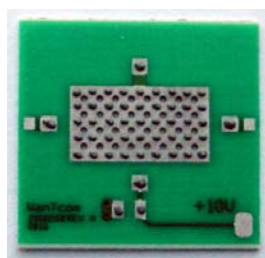

Fig. 2 Dispensed solder paste

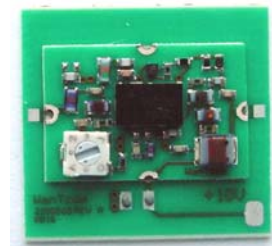

Fig. 3 Assembled preamp

B. Assembly

The high temperature solder is used internally center chip assembly. The melting temperature point of the high temperature solder is around 240 °C. Thus, melting temperature of the solder paste should be way below 240 °C for assembling the pre-amp on the test board or feed board.

For high reliability product, Lead SN63/Pb63 solder paste, which melting temperature point being around 183 °C, is recommended for the assembly purpose.

For RoHS requirement, Bismuth based Lead free solder paste such as 60Sn/40Bi is suitable for the assembly.

Warning: regular SAC305 RoHS reflow process will damage the pre-amp!

The solder paste can be dispensed by a needle manually or driven by a compressed air. **Figure 2** shows the example of the dispensed solder paste pattern. Each solder paste dot is in the diameter of 0.005" ~ 0.010" (0.125 ~ 0.250 mm).

For volume assembly, a stencil with 0.006" (0.15 mm) is recommended to print the solder paste on the circuit board.

For more detail assembly process, refer to AN-109 at www.wantcominc.com website.
