



# WMA1T5AE

## 1.5T LOW NOISE PRE-AMPLIFIER

REV C  
August 2022

### Key Features



- For 50 Ohm Source Impedance
- 1.5T Frequency of 63.8 MHz
- 1.5 Ohm Input Impedance
- 0.5 dB Noise Figure
- 30.0 dBm Max  $P_{IN}$
- 24.0 dBm Output  $IP_3$
- 28.0 dB Gain
- 8.0 dBm  $P_{1dB}$
- 1.22:1 Output VSWR
- Unconditional Stable,  $k > 1$
- Single Power Supply
- Non Magnetic

### Product Description

With its low input impedance, WMA1T5AE is designed for 50 Ohm source impedance multi-channel coil applications. The pre-amp maintains excellent noise figure performance over source impedance variation that either comes from the different loads to the coils or not ideal design implementation of the coils. Moreover, the pre-amp allows higher source impedance design to increase the blocking impedance while maintaining superior SNR due to large equal noise circles. The amplifier has 0.40" x 0.25" x 0.08" surface mount package.

CAUTION:



ELECTROSTATIC DISCHARGE SENSITIVE

### Applications

- Magnetic Resonance Imaging
- RF Measurement
- Medical
- Current Sensor



### Specifications

Summary of the key electrical specifications at room temperature, tested in the WanTcom fixture, 8000022

Index	Testing Item	Symbol	Test Constraints	Min	Nom	Max	Unit
1	Gain	$S_{21}$	63.8 MHz, Factory test condition		28.0		dB
2	Gain Variation	$\Delta G$	63.8 +/- 1 MHz		+/-0.05	+/- 0.1	dB
3	Input Impedance	RE [Zin]	63.8 MHz		1.5	2.0	Ohm
		IM [Zin]	63.8 MHz, with test fixture 8000022	-6.0	-3.0	0	Ohm
4	Output VSWR, 50 Ohm Impedance	$SWR_2$	63.8 MHz			1.22:1	Ratio
5	Reverse Isolation	$S_{12}$	63.8 MHz	60	70		dB
6	Noise Figure	NF	63.8 MHz, $Z_s=50$ Ohm		0.47	0.60	dB
7	Output Power 1dB Compression Point	$P_{1dB}$	63.8 MHz	7	9		dBm
8	Output-Third-Order Interception Point	$IP_3$	Two-Tone, $P_{out} = 0$ dBm each, $f_1-f_2 = 1$ MHz	20	24		dBm
9	Current Consumption	$I_{dd}$	$V_{dd}=+10.0$ V, Factory test condition		14		mA
10	Power Supply Operating Voltage	$V_{dd}$		+7	+10	+13	V
11	Thermal Resistance	$R_{th,c}$	Junction to case			215	$^{\circ}C/W$
12	Operating Temperature	$T_o$		+10		+60	$^{\circ}C$
13	Maximum RF Input Power	$P_{IN,MAX}$	DC - 6.0 GHz, 10% Duty Cycle, $Z_s=50$ Ohm			30	dBm
14	Saturate Recover Time	$t_{sr}$	10% to 90% from 20 dBm Pin, $Z_s = 50$ Ohm		4	8	$\mu S$
15	ESD Protection, None Contact	$V_{ESDN}$	Output Port			16	kV
16	ESD Protection, Direct Contact	$V_{ESD}$	Output Port			6	kV

### Absolute Maximum Ratings

Parameters	Units	Ratings
DC Power Supply Voltage	V	13.0
Drain Current	mA	30
Total Power Dissipation	mW	350
RF Input Power, 10% Duty Cycle	dBm	30
Junction Temperature	$^{\circ}C$	150
Storage Temperature	$^{\circ}C$	-65 ~ 150
Operating Temperature	$^{\circ}C$	0 ~ +70
Thermal Resistance <sup>1</sup>	$^{\circ}C/W$	215

Operation beyond any one of these parameters may cause permanent damage.

### Ordering Information

<sup>1</sup> The last stage transistor dominates the heat dissipation. The drain bias voltage is +6V and the drain current is 10.0 mA. The total power dissipation of the last stage transistor is thus 60 mW. The junction temperature arise  $0.06 \times 215 = 13 (^{\circ}C)$ .

Specifications and information are subject to change without notice.

### Functional Block Diagram

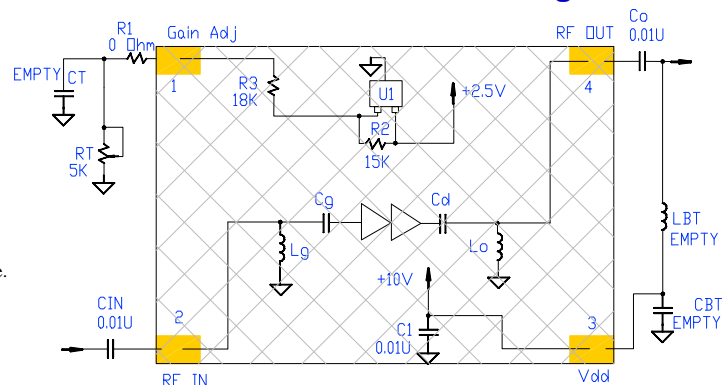



# WMA1T5AE

## 1.5T LOW NOISE PRE-AMPLIFIER

REV C  
August 2022

Model Number	WMA1T5AE
--------------	----------

ESD tube is used for the packing. Contact factory for tape and reel packing option for higher volume order.

### Typical Data

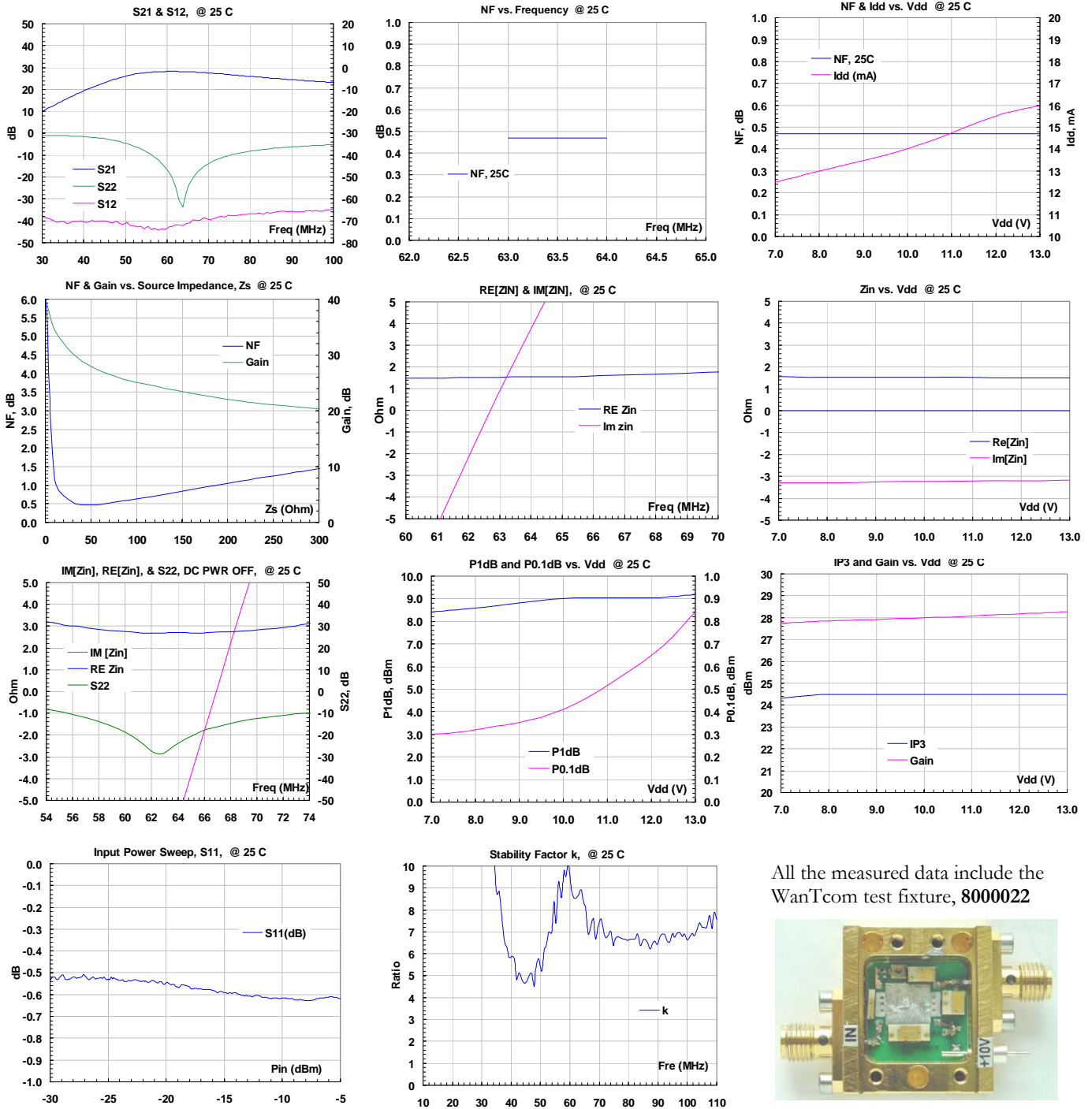

All the measured data include the WanTcom test fixture, 800022

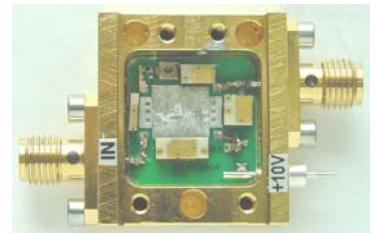

Specifications and information are subject to change without notice.



## Outline

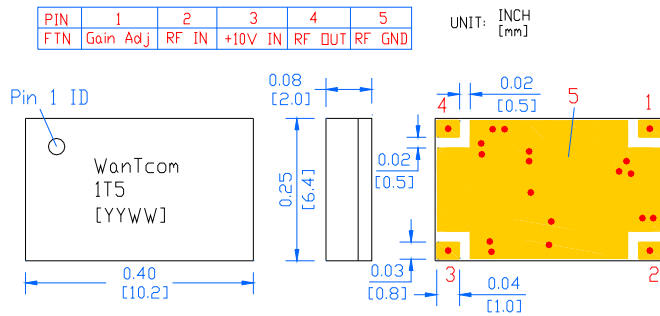

## Foot Print/Mounting Layout

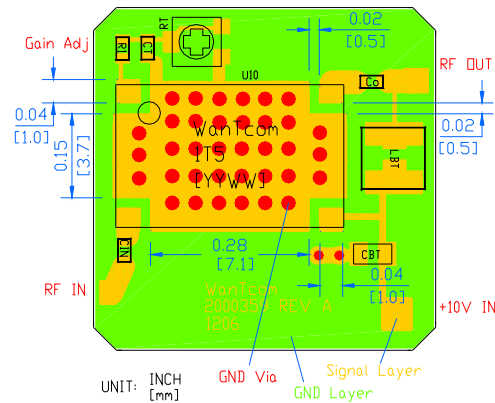

## Application Notes:

### A. Motherboard Layout

The recommended motherboard layout is shown in diagram of **Foot Print/Mounting Layout**. Sufficient numbers of ground vias on center ground pad are essential for the RF grounding. The width of the 50-Ohm microstrip lines at the input and output RF ports may be different for different property of the substrate. The ground plane on the backside of the substrate is needed to connect the center ground pad through the vias. The ground plane is also essential for the 50-Ohm microstrip line launches at the input and output ports.

The +10V DC voltage is applied at Pin 3 or at the output Pin 4, which requires LBT inductor of 2.2 uH. DC block capacitors, CIN and Co of 0.01 uF, are required at input and output RF ports.

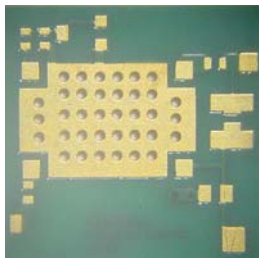

Fig. 1 Example of the motherboard

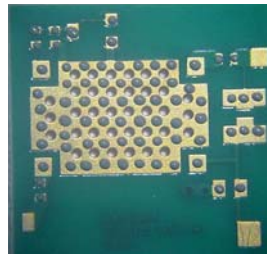

Fig. 2 Dispensed solder paste



Fig. 3 Assembled part

### B. Assembly

The regular low temperature and none clean solder paste such as SN63 is recommended. The high temperature solder has been used internally for the WHM series amplifier assembly. The melting temperature point of the high temperature solder is around 217 ~ 220 °C. Thus, melting temperature of the solder paste should be below 217 °C for assembling the amplifier on the test board to reduce the possible damage. The temperature melting point of the SN63 solder paste is around 183 °C and is suitable for the assembly purpose.

The SN63 solder paste can be dispensed by a needle manually or driven by a compressed air. **Figure 2** shows the example of the dispensed solder paste pattern. Each solder paste dot is in the diameter of 0.005" ~ 0.010" (0.125 ~ 0.250 mm).

For volume assembly, a stencil with 0.006" (0.15 mm) is recommended to print the solder paste on the circuit board.

For more detail assembly process, refer to AN-109 at [www.wantcominc.com](http://www.wantcominc.com) website.

\*\*\*\*\*