



# WMAS9RA-R5

## 9.4T ROOM TEMP SUPERCONDUCTOR-LIKE PREAMPLIFIER

REV B

October 2023

### Key Features



- For 50 Ohm Source Impedance
- 9.4T Frequency of 400.4 MHz
- 0.5 Ohm Input Impedance
- **0.25 dB Noise Figure**
- 35.0 dBm Max  $P_{IN}$
- 21.0 dBm Output  $IP_3$
- 28.0 dB Gain @  $Z_s = 50 \Omega$
- 10.0 dBm Output  $P_{1dB}$
- 1.22:1 Output VSWR
- Unconditional Stable,  $k > 1$
- Single Power Supply
- Non Magnetic

### Product Description

With its low input impedance, WMAS9RA-R5 is a room temperature superconductor-like MRI preamplifier (preamp) for multi-channel coil applications. Due to its large equal noise circles, the preamp maintains excellent noise figure over wide source impedance variation that either comes from the different coil loads or non-ideal design implementation of the coils. Moreover, the preamp allows higher source impedance design to increase the blocking impedance while maintaining superior SNR. The amplifier has 0.60" x 0.40" x 0.10" surface mount package.



### Applications

- Magnetic Resonance Imaging
- RF Measurement
- Medical
- Current Sensor



Other frequencies and impedance available!

### Specifications

Summary of the key electrical specifications at room temperature of 21 °C, tested in the WanTcom fixture, 80051.

Item	Test Parameter	Symbol	Test Constraint	Min	Nom	Max	Unit
1	Gain	$S_{21}$	400.4 MHz, $Z_s = 50 \Omega$	27.5	28.0	28.5	dB
2	Gain Variation	$\Delta G$	400.4 +/- 1 MHz		+/-0.05	+/- 0.1	dB
3	Input Impedance	RE [Zin]	400.4 MHz	0.35	0.5	0.7	Ohm
		IM [Zin]	400.4 MHz, with 80051, which has 0.085 pS electrical length @ input port	-2.0	0	2.0	Ohm
4	Output VSWR, $Z_s = 50 \Omega$	$SWR_2$	400.4 MHz			1.22:1	Ratio
5	Reverse Isolation	$S_{12}$	400.4 MHz	65	75		dB
6	Noise Figure	NF	400.4 MHz, $Z_s = 50 \Omega$ , -6 dB pad method <sup>1</sup>		<b>0.25</b>	0.35	dB
7	Output 1dB Gain Compression Point	$P_{1dB}$	400.4 MHz	8	10		dBm
8	Output-Third-Order Interception Point	$IP_3$	Two-Tone, $P_{out} = -5$ dBm each, 1 MHz separation	18	21		dBm
9	DC Current Consumption	$I_{dd}$	$V_{dd} = +10.0$ V		17		mA
10	DC Power Supply Operating Voltage	$V_{dd}$		+7	+10	+12	V
11	Thermal Resistance	$R_{th,c}$	Junction to case			215	°C/W
12	Operating Temperature	$T_o$		+10		+60	°C
13	Maximum RF Input Power	$P_{IN,MAX}$	400.4 MHz, 6% Duty Cycle, $Z_s = 50$ Ohm			35	dBm
14	Saturate Recover Time	$t_{sr}$	10% to 90% from 20 dBm Pin, $Z_s = 50$ Ohm		2	4	uS
15	ESD Protection, None Contact	$V_{ESDN}$	Output Port			18	kV
16	ESD Protection, Direct Contact	$V_{ESD}$	Output Port			8	kV

### Absolute Maximum Ratings

Parameter	Unit	Rating
DC Power Supply Voltage	V	-0.5/15.0
Drain Current	mA	30
Total Power Dissipation	mW	350
RF Input Power, 6% Duty Cycle	dBm	35
Junction Temperature	°C	150
Storage Temperature	°C	-40 ~ 125
Operating Temperature	°C	0 ~ +70
Thermal Resistance <sup>2</sup>	°C/W	215

Operation of this device beyond any one of these parameters may cause permanent damage.

<sup>1</sup> Refers to AN-154, AN-106.

<sup>2</sup> The last stage transistor dominates the heat dissipation. The drain bias voltage is +6V and the drain current is 12.0 mA. The total power dissipation of the last stage transistor is thus 72 mW. The junction temperature arise  $0.072 \times 215 = 16$  (°C).

Specifications and information are subject to change without notice.

### Functional Block Diagram

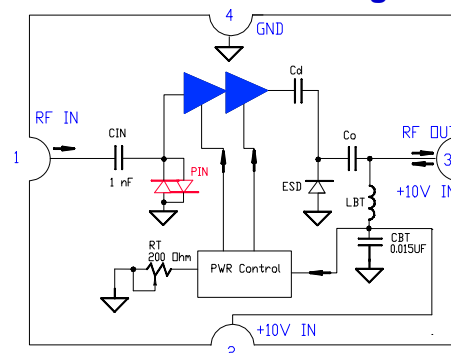



### Ordering Information

<b>Model Number</b>	WMAS9RA-R5
---------------------	------------

10 x 10 ESD Tray is used for the packing. Contact factory for other packing options.

### Typical Performance Data

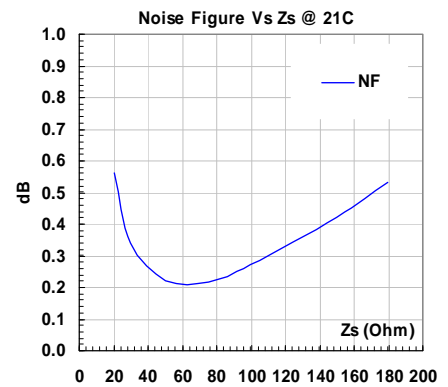
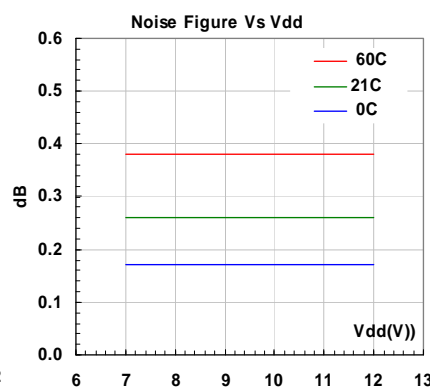
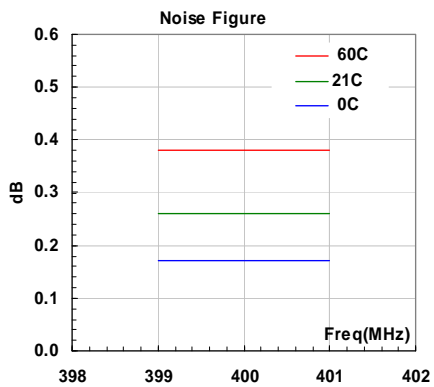
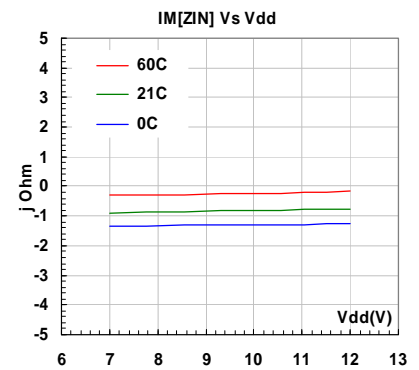
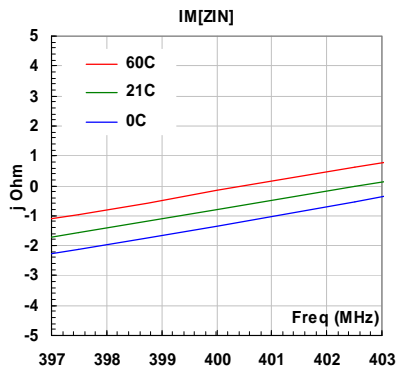
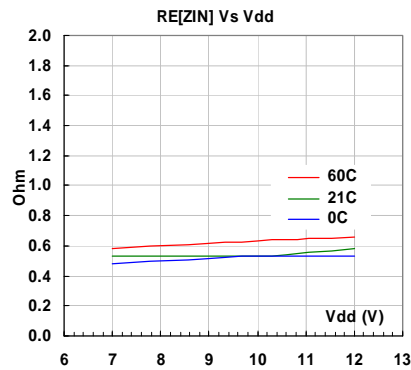
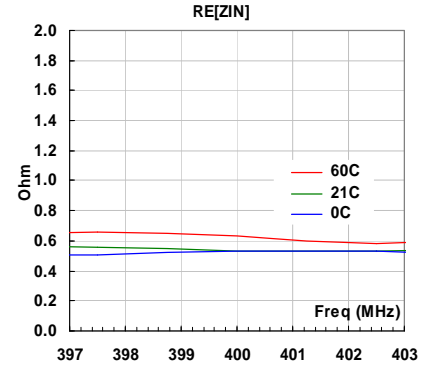
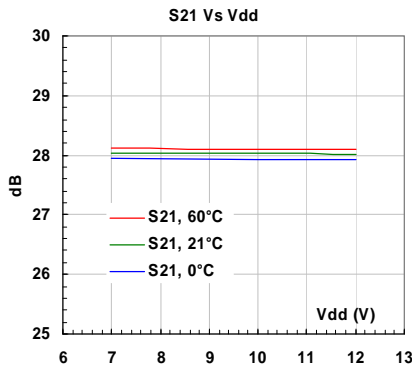
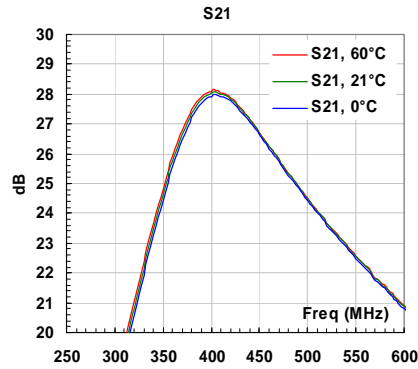

Specifications and information are subject to change without notice.



# WMAS9RA-R5

## 9.4T ROOM TEMP SUPERCONDUCTOR-LIKE PREAMPLIFIER

REV B  
October 2023

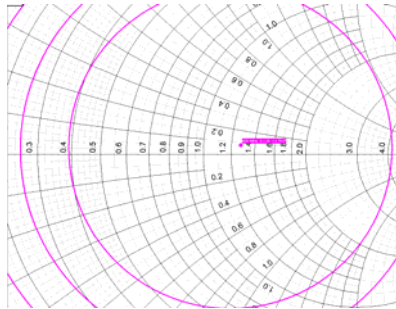

Noise Circles

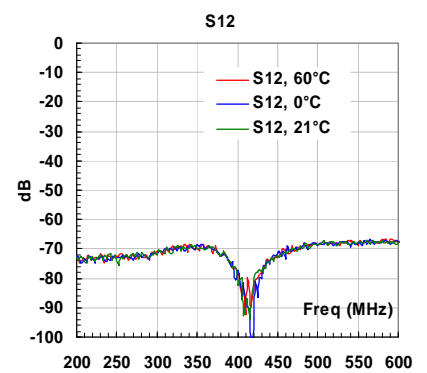
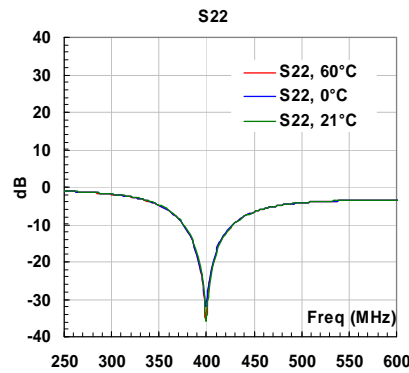
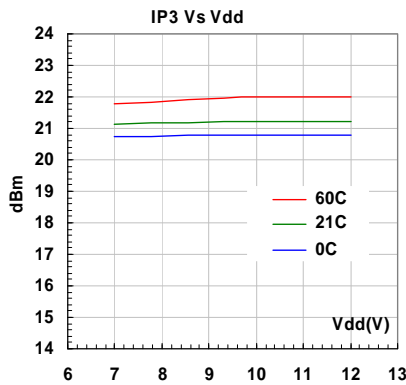
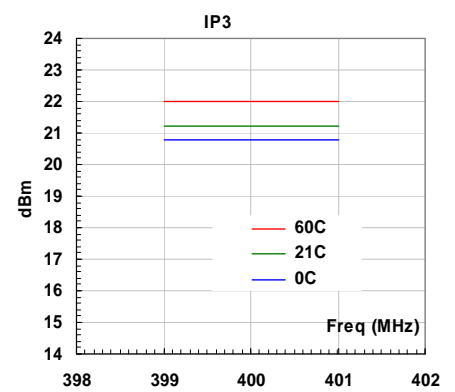
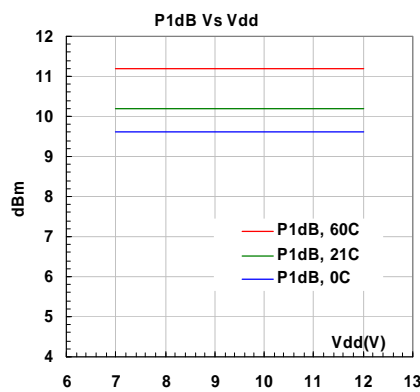
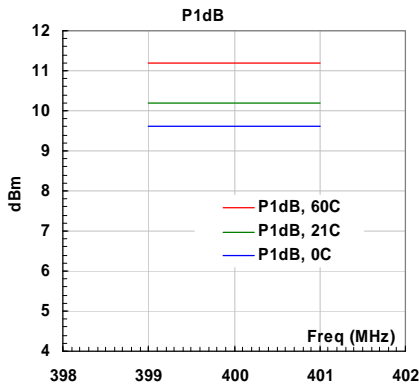
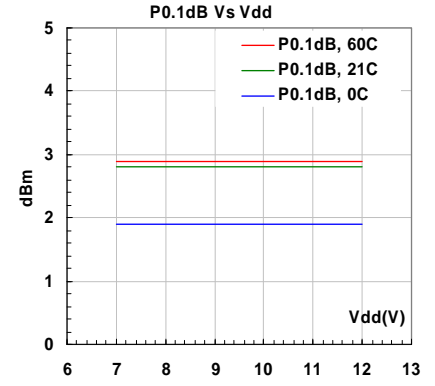
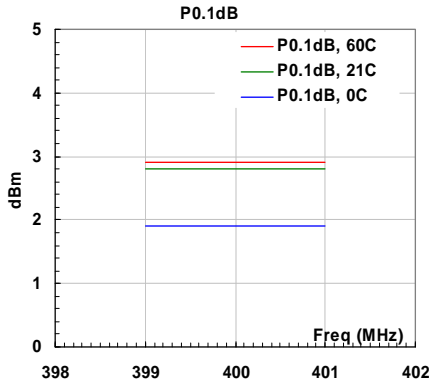

Specifications and information are subject to change without notice.

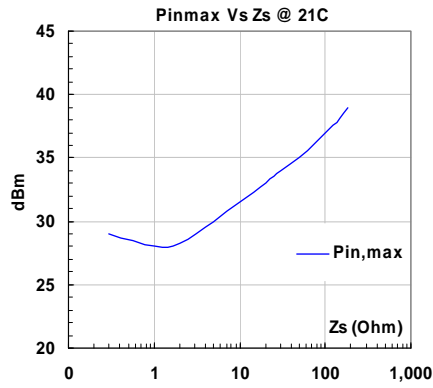
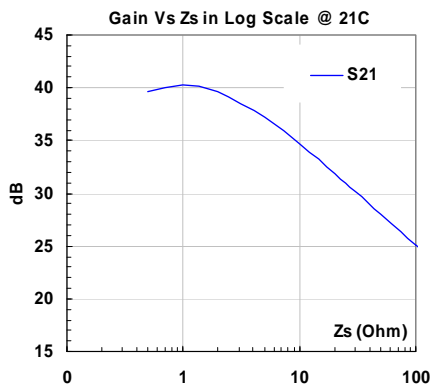
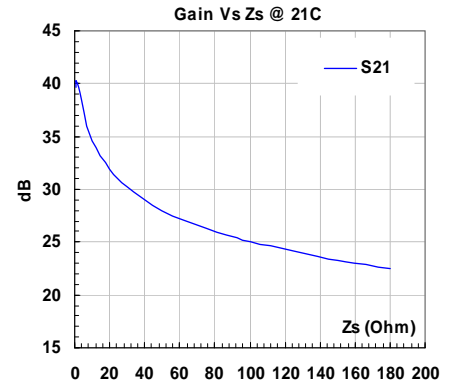
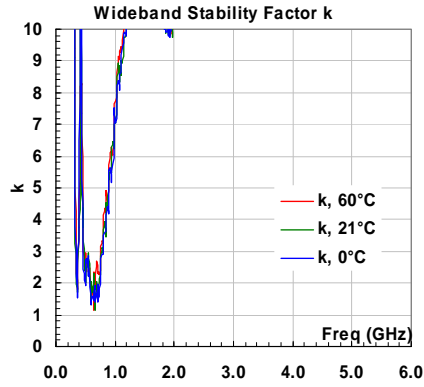
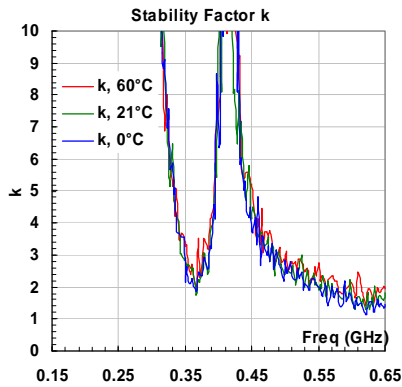

### Outline,

PIN	1	2	3	4	CNTR
FCTN	IN	NC/10V	OUT/10V	GND	GND

UNITS: INCH [mm]  
FINISH: WHITE TIN

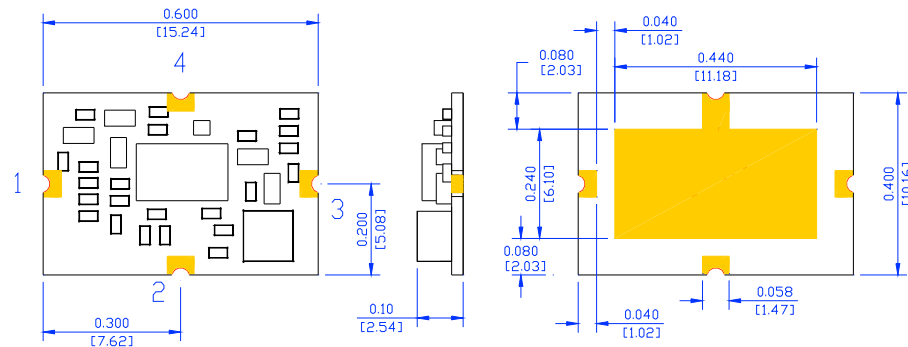

Specifications and information are subject to change without notice.



### Foot Print/Mounting Layout

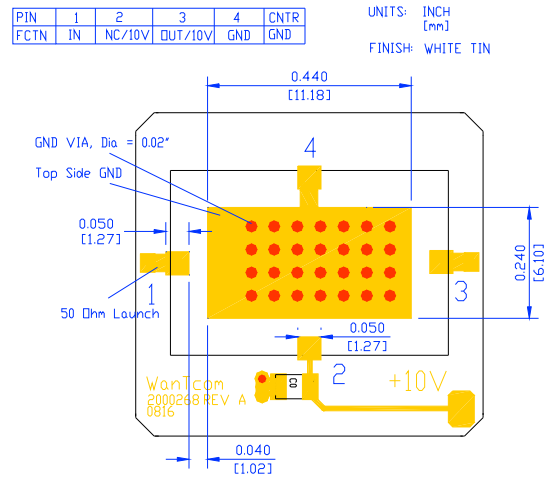

### Application Notes:

#### A. Motherboard Layout

The recommended motherboard layout is shown in the diagram of **Foot Print/Mounting Layout**. Sufficient quantities of ground vias on center ground paddle are essential for the RF grounding. The width of the 50-Ohm microstrip lines at the input and output RF ports may be different for different property of the substrate. The ground plane on the backside of the substrate is needed to connect the center ground paddle through the vias. The ground plane is also essential for the 50-Ohm microstrip line launches at the input and output ports.

In order to have stable preamp in the coil system, the minimum system isolation of 65 dB between the input and output soldering pads for the preamp with all the feed board components including the coils on the feed board is required. Poor system isolation can introduce possible external feedback either in pass band or off band and cause the preamp having parasitic oscillation. Measuring the  $S_{12}$  or  $S_{21}$  between the input and output pads without the installation of the preamp is essential to insure the isolation is better than 65 dB. Shorter output path or even shielded output circuitry is recommended for better isolation.

The +10V DC voltage can be applied at Pin 2 or at the output Pin 3. There is a built-in bias-T at the output port to separate the RF output signal and the input +10V DC power supply. Pin 2 and Pin 3 are DC connected internally which has 120 mA maximum DC current rating between the 2 ports.

No DC block capacitor is required at input port.

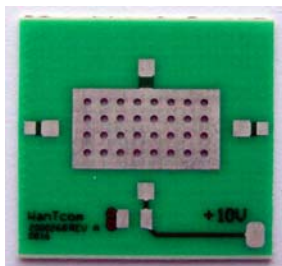

Fig. 1 Example of the test board

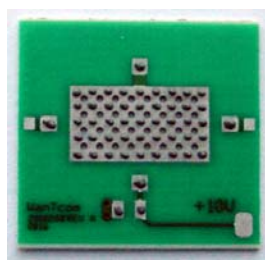

Fig. 2 Dispensed solder paste

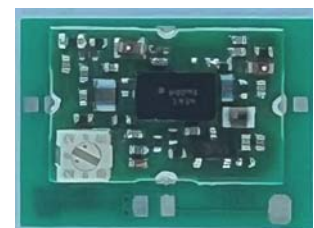

Fig. 3 Assembled preamp



### B. Assembly

The high temperature solder is used internally center chip assembly. The melting temperature point of the high temperature solder is around 240 °C. Thus, melting temperature of the solder paste should be way below 240 °C for assembling the pre-amp on the test board or feed board.

For high reliability product, RoHS 40Bi/60SN solder paste, which melting temperature point being around 180 °C, is recommended for the assembly purpose.

For RoHS requirement, Bismuth based Lead free solder paste such as 60Sn/40Bi is suitable for the assembly.

**Warning: regular SAC305 RoHS reflow process will damage the pre-amp!**

The solder paste can be dispensed by a needle manually or driven by a compressed air. **Figure 2** shows the example of the dispensed solder paste pattern. Each solder paste dot is in the diameter of 0.005" ~ 0.010" (0.125 ~ 0.250 mm).

For volume assembly, a stencil with 0.006" (0.15 mm) is recommended to print the solder paste on the circuit board.

For more detail assembly process, refer to AN-109 at [www.wantcominc.com](http://www.wantcominc.com) website.

### C. Input Protection

Even though there is a built-in cross diodes, the preamp cannot survive beyond 35 dBm transmitting (TX) power at 50 Ohm source impedance. The maximum input power, Pinmax, is different at the different source impedance. The lowest Pinmax happens at the  $Z_s$  being around 1.0 Ohm, refers to the last curve in page 4. Thus, increase the source impedance during the TX cycle is better than lower the impedance from preamp protection point of view.

Additional protection such as coil detuning and adding coarse limiter are needed depending on the TX power and spacial isolation between the TX coil and receiving coils.

### D. Dog-Ears Effect

The gain goes higher as  $Z_s$  decreases and peaks at around 1.0 Ohm (conjugate matching between the source and preamp). Due to  $Z_s$  (designed to be 50 Ohm at MRI frequency) from a coil circuitry are around 1.0 Ohm at upper and lower sides frequencies by the MRI frequency, the dual gain peaks occur, so called Dog-Ears effect. The gain peaks can be around 22 dB higher than that at the MRI frequency using this 0.5 Ohm input impedance preamp. It has been a challenge to coil designers to keep the preamp stable for decades since using low input impedance preamps. Thus, the feed board layout for good isolation of minimum 65 dB is critical to prevent the oscillation at the Dog-Ears frequencies.

### E. Source Impedance Selection

The noise figure is below 0.30 dB at the source impedance,  $Z_s$ , ranging from 40 to 100 Ohm. The optimum noise figure of 0.20 dB happens around  $Z_s = 65$  Ohm while the gain is still over 26 dB. The higher the source impedance, the higher the coil blocking impedance and the wider span of the Dog-Ears frequencies will be achieved.

\*\*\*\*\*